

Pb Free Plating Product

## KIA50N06



## 50A,60V Heatsink Planar N-Channel Power MOSFET

## Features

- 50A, 60V,  $R_{DS(on)} = 0.022$  @  $V_{GS} = 10$  V
- Low gate charge ( typical 31 nC)
- Low Crss ( typical 65 pF)
- Fast switching
- 100% avalanche tested
- Improved dv/dt capability
- 175 C maximum junction temperature rating

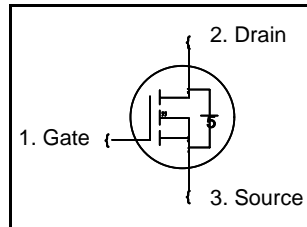

$BV_{DSS} = 60V$

$R_{DS(ON)} = 0.022 \text{ ohm}$

$I_D = 50A$

## General Description

This N-channel enhancement mode field-effect power transistor using THINKI Semiconductor advanced planar stripe, DMOS technology intended for off-line switch mode power supply.

Also, especially designed to minimize  $r_{ds(on)}$  and high rugged avalanche characteristics. The TO-220M-SQ pkg is well suited for adaptor power units, amplifiers, inverters and SMPS application.

## Absolute Maximum Ratings

 $T_C = 25^\circ\text{C}$  unless otherwise noted

Symbol	Parameter	KIA50N06	Units
$V_{DSS}$	Drain-Source Voltage	60	V
$I_D$	Drain Current - Continuous ( $T_C = 25^\circ\text{C}$ ) - Continuous ( $T_C = 100^\circ\text{C}$ )	50	A
		35.4	A
$I_{DM}$	Drain Current - Pulsed (Note 1)	200	A
$V_{GSS}$	Gate-Source Voltage	25	V
$E_{AS}$	Single Pulsed Avalanche Energy (Note 2)	490	mJ
$I_{AR}$	Avalanche Current (Note 1)	50	A
$E_{AR}$	Repetitive Avalanche Energy (Note 1)	12	mJ
dv/dt	Peak Diode Recovery dv/dt (Note 3)	7.0	V/ns
$P_D$	Power Dissipation ( $T_C = 25^\circ\text{C}$ ) - Derate above $25^\circ\text{C}$	120	W
		0.8	W/ $^\circ\text{C}$
$T_J, T_{STG}$	Operating and Storage Temperature Range	-55 to +175	$^\circ\text{C}$
$T_L$	Maximum lead temperature for soldering purposes, 1/8" from case for 5 seconds	300	$^\circ\text{C}$

## Thermal Characteristics

Symbol	Parameter	Typ	Max	Units
$R_{JC}$	Thermal Resistance, Junction-to-Case	--	1.24	$^\circ\text{C}/\text{W}$
$R_{CS}$	Thermal Resistance, Case-to-Sink	0.5	--	$^\circ\text{C}/\text{W}$
$R_{JA}$	Thermal Resistance, Junction-to-Ambient	--	62.5	$^\circ\text{C}/\text{W}$

## Electrical Characteristics

$T_C = 25^\circ\text{C}$  unless otherwise noted

Symbol	Parameter	Test Conditions	Min	Typ	Max	Units
<b>Off Characteristics</b>						
$BV_{DSS}$	Drain-Source Breakdown Voltage	$V_{GS} = 0\text{ V}, I_D = 250\text{ A}$	60	--	--	V
$\frac{BV_{DSS}}{T_J}$	Breakdown Voltage Temperature Coefficient	$I_D = 250\text{ A}$ , Referenced to $25^\circ\text{C}$	--	0.06	--	$\text{V}/^\circ\text{C}$
$I_{DSS}$	Zero Gate Voltage Drain Current	$V_{DS} = 60\text{ V}, V_{GS} = 0\text{ V}$	--	--	1	A
		$V_{DS} = 48\text{ V}, T_C = 150^\circ\text{C}$	--	--	10	A
$I_{GSSF}$	Gate-Body Leakage Current, Forward	$V_{GS} = 25\text{ V}, V_{DS} = 0\text{ V}$	--	--	100	nA
$I_{GSSR}$	Gate-Body Leakage Current, Reverse	$V_{GS} = -25\text{ V}, V_{DS} = 0\text{ V}$	--	--	-100	nA

## On Characteristics

$V_{GS(th)}$	Gate Threshold Voltage	$V_{DS} = V_{GS}, I_D = 250\text{ A}$	2.0	--	4.0	V
$R_{DS(on)}$	Static Drain-Source On-Resistance	$V_{GS} = 10\text{ V}, I_D = 25\text{ A}$	--	0.018	0.022	
$g_{FS}$	Forward Transconductance	$V_{DS} = 25\text{ V}, I_D = 25\text{ A}$ (Note 4)	--	22	--	S

## Dynamic Characteristics

$C_{iss}$	Input Capacitance	$V_{DS} = 25\text{ V}, V_{GS} = 0\text{ V},$ $f = 1.0\text{ MHz}$	--	1180	1540	pF
$C_{oss}$	Output Capacitance		--	440	580	pF
$C_{riss}$	Reverse Transfer Capacitance		--	65	90	pF

## Switching Characteristics

$t_{d(on)}$	Turn-On Delay Time	$V_{DD} = 30\text{ V}, I_D = 25\text{ A},$ $R_G = 25$  (Note 4, 5)	--	15	40	ns
$t_r$	Turn-On Rise Time		--	105	220	ns
$t_{d(off)}$	Turn-Off Delay Time		--	60	130	ns
$t_f$	Turn-Off Fall Time		--	65	140	ns
$Q_g$	Total Gate Charge	$V_{DS} = 48\text{ V}, I_D = 50\text{ A},$ $V_{GS} = 10\text{ V}$  (Note 4, 5)	--	31	41	nC
$Q_{gs}$	Gate-Source Charge		--	8	--	nC
$Q_{gd}$	Gate-Drain Charge		--	13	--	nC

## Drain-Source Diode Characteristics and Maximum Ratings

$I_S$	Maximum Continuous Drain-Source Diode Forward Current	--	--	50	A	
$I_{SM}$	Maximum Pulsed Drain-Source Diode Forward Current	--	--	200	A	
$V_{SD}$	Drain-Source Diode Forward Voltage	$V_{GS} = 0\text{ V}, I_S = 50\text{ A}$	--	--	1.5	V
$t_{rr}$	Reverse Recovery Time	$V_{GS} = 0\text{ V}, I_S = 50\text{ A},$ $di_F / dt = 100\text{ A/s}$ (Note 4)	--	52	--	ns
$Q_{rr}$	Reverse Recovery Charge		--	75	--	nC

### Notes:

1. Repetitive Rating : Pulse width limited by maximum junction temperature
2.  $L = 230\text{ nH}, I_{AS} = 50\text{ A}, V_{DD} = 25\text{ V}, R_G = 25$  Starting  $T_J = 25^\circ\text{C}$
3.  $I_{SD} \leq 50\text{ A}, di/dt \leq 300\text{ A/s}, V_{DD} \leq BV_{DSS}$ , Starting  $T_J = 25^\circ\text{C}$
4. Pulse Test : Pulse width  $\leq 300\text{ s}$ , Duty cycle  $\leq 2\%$
5. Essentially independent of operating temperature

### Typical Characteristics

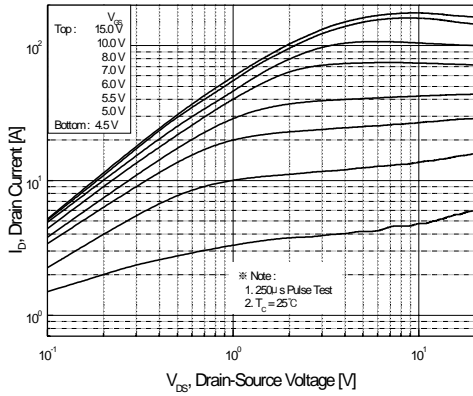

Figure 1. On-Region Characteristics

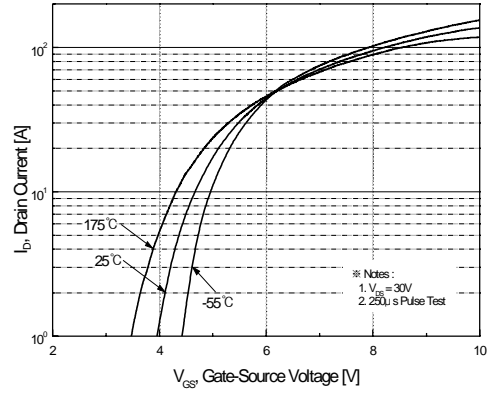

Figure 2. Transfer Characteristics

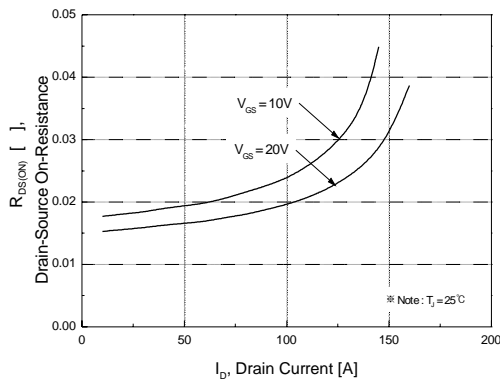

Figure 3. On-Resistance Variation vs. Drain Current and Gate Voltage

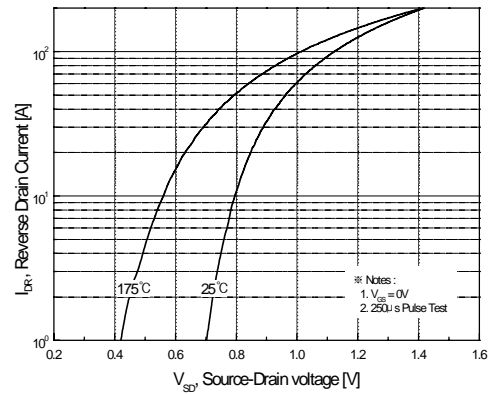

Figure 4. Body Diode Forward Voltage Variation vs. Source Current and Temperature

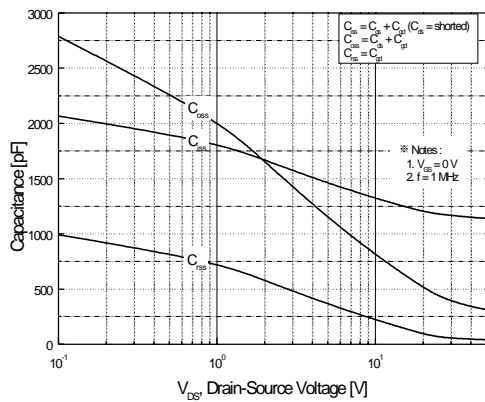

Figure 5. Capacitance Characteristics

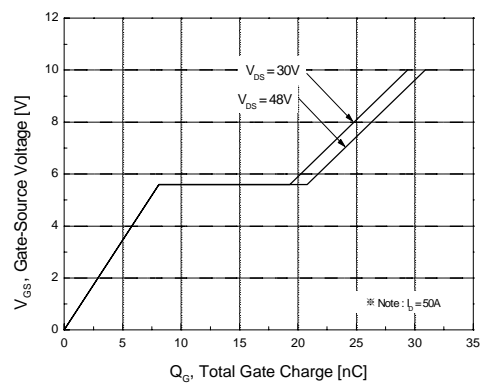

Figure 6. Gate Charge Characteristics

Typical Characteristics (Continued)

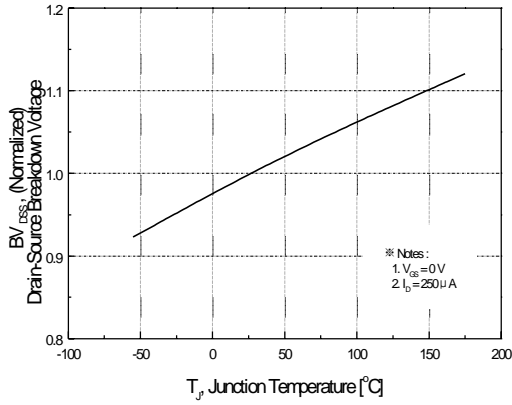

Figure 7. Breakdown Voltage Variation vs. Temperature

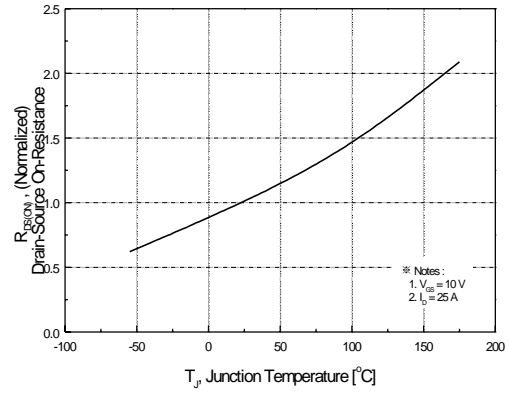

Figure 8. On-Resistance Variation vs. Temperature

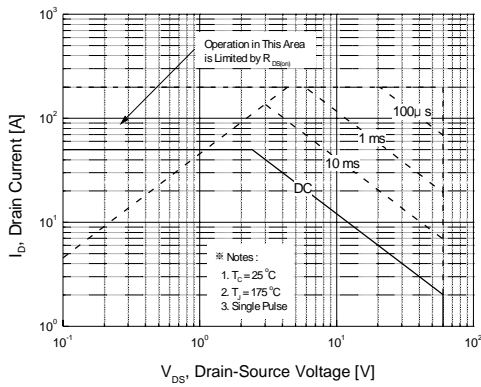

Figure 9. Maximum Safe Operating Area

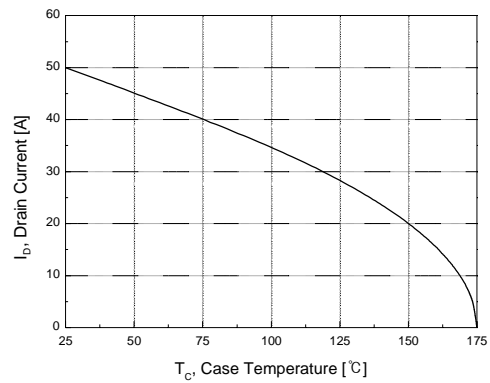

Figure 10. Maximum Drain Current vs. Case Temperature

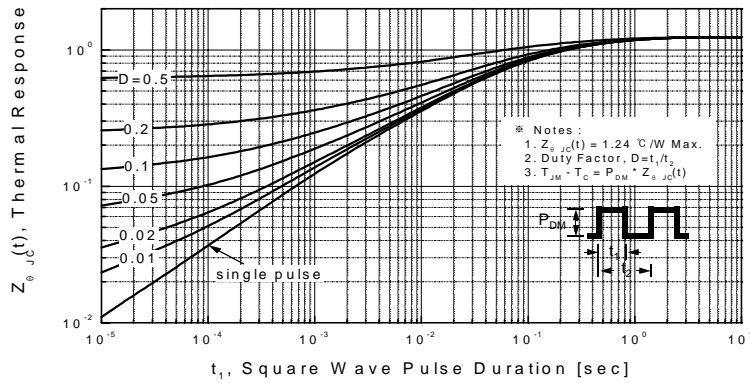
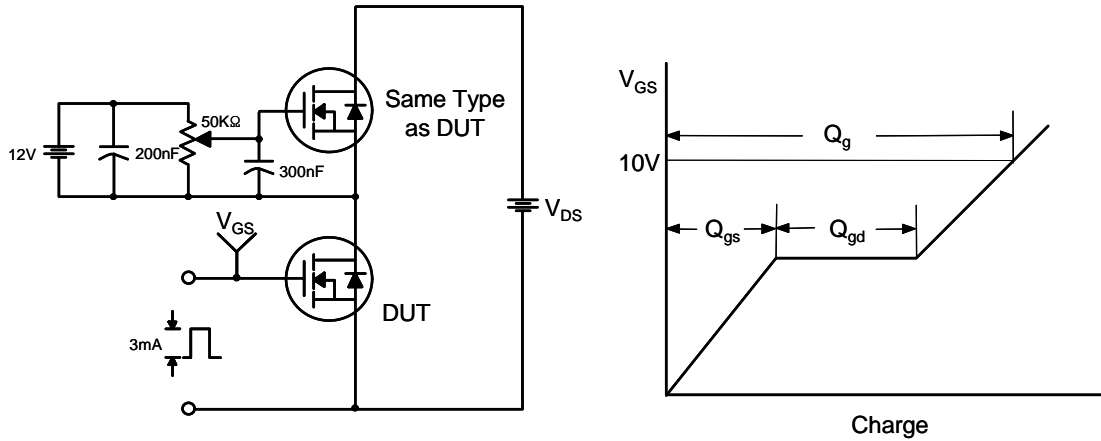
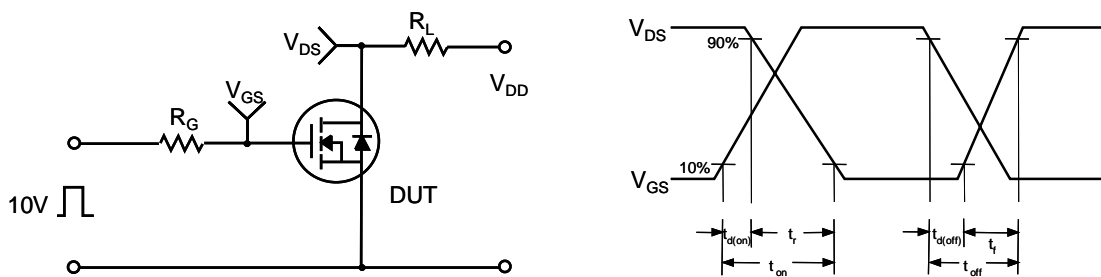

Figure 11. Transient Thermal Response Curve

Gate Charge Test Circuit & Waveform



Resistive Switching Test Circuit & Waveforms



Unclamped Inductive Switching Test Circuit & Waveforms

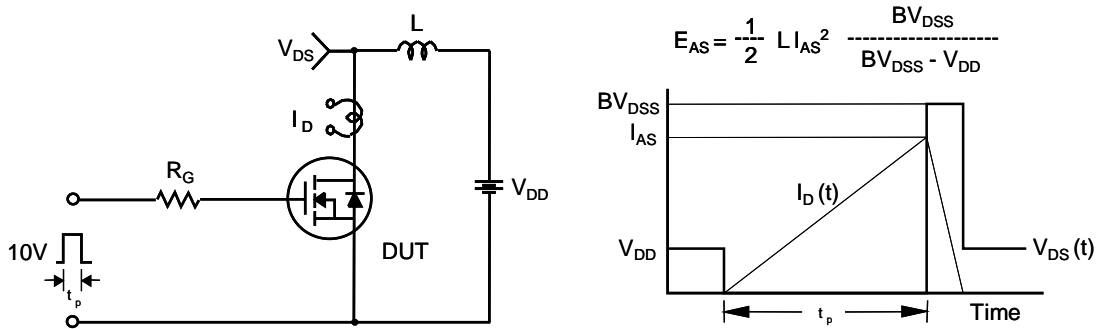

Peak Diode Recovery dv/dt Test Circuit & Waveforms

